

Article number: 6160403535

Description: Welding hub for taper bush type MSB
for taper bush 3535

Measures

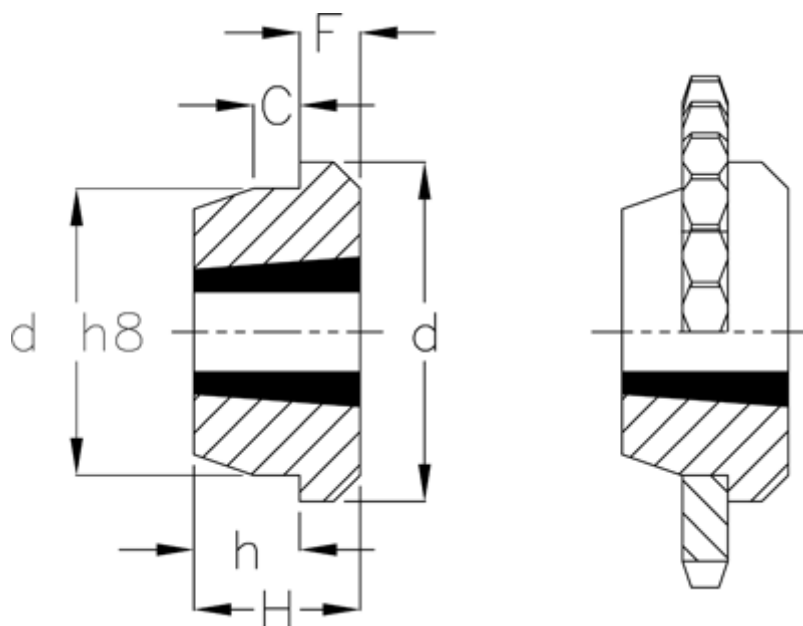

C	= 25
d	= 184
d H8	= 155
F	= 32
For taper bush = 3535	
H	= 89
h	= 57